

TEKNİK DEĞERLER TABLOSU

3 FAZLI ASENKRON ELEKTRİK MOTORU	
Tip	VEMO 90-6
Koruma Sınıfı	IP55
Yalıtım Sınıfı	F

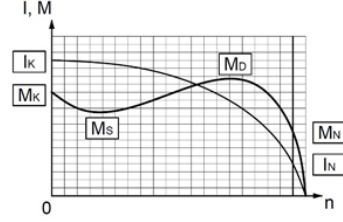

İŞLETME DEĞERLERİ (TAM YÜK)

TİP Yapı Büyüklüğü	Model	Gerilim (V)	Anma Akım (A)	Giriş Gücü (kW)	Motor Hızı (1/dak)	Rulman No	Takribi Ağırlık (kg)	Vibrasyon Kuvveti						
								Max. %100 (kgf)	2.Kad. %95 (kgf)	3.Kad. %85 (kgf)	4.Kad. %70 (kgf)	5.Kad. %50 (kgf)	Min. %30 (kgf)	
VEMO 90-6	1	380	1,51	0.5	1000	6306 ZZ	28							

MEKANİK DEĞERLER

Gövde	Boru Döküm	Rulmanlar	6306
Klemens Kutusu	Sfero Döküm	Renk	RAL 6028-Yeşil
Rakor Küçük Plastik	Pg 11	Yaklaşık ağırlık (kg)	28
Rakor Büyük Prinç	-		

MODEL 1

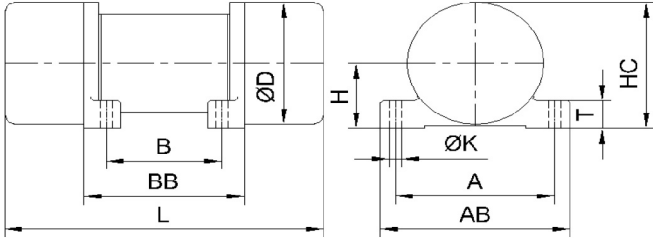

MODEL 2

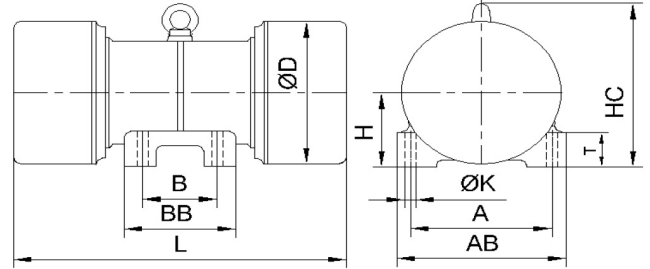

MODEL 3A

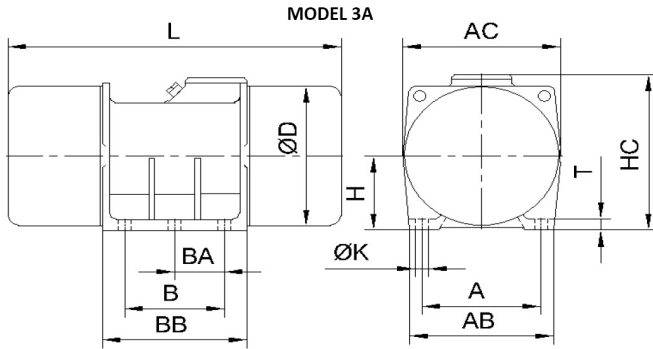

MODEL 3B

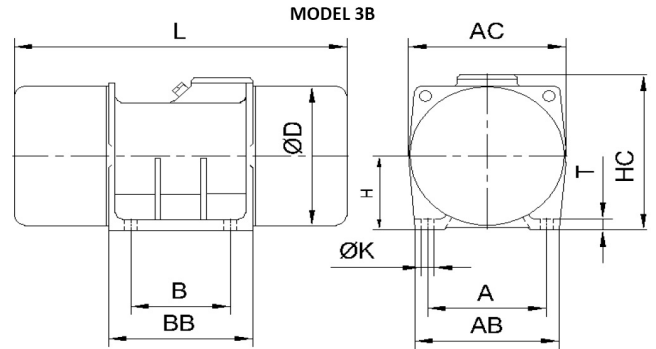

TİP	Model	Giriş Gücü (kW)	A	AB	AC	B	BB	BA	D	H	HC	K	T	L
VEMO 90-6	1	0.5												